

19285

(D) MONTAGEANLEITUNG:	SEITENWAND IN FLUCHT
(GB) INSTALLATION INSTRUCTIONS:	SIDE WALL IN PLANE
(F) NOTICE DE MONTAGE:	PAROI FIXE MEME HT EN PLAN
(CZ) NÁVOD K MONTÁŽI:	BOČNÍ STĚNA V ROVINĚ
(PL) INSTRUKCJA MONTAŻU:	ŚCIANA BOCZNA W PŁASZCZYŹNIE
(SK) NÁVOD NA MONTÁŽ:	BOČNÁ STENA V ROVINE
(RU) ИНСТРУКЦИЯ ПО МОНТАЖУ:	ФИКСИРОВАННАЯ ПАНЕЛЬ В ОДНОЙ ЛИНИИ
(E) INSTRUCCIONES DE MONTAJE:	PARED LATERAL A NIVEL
(RO) INSTRUCȚIUNI DE MONTAJ:	PARTE FIXĂ ÎN CONTINUARE

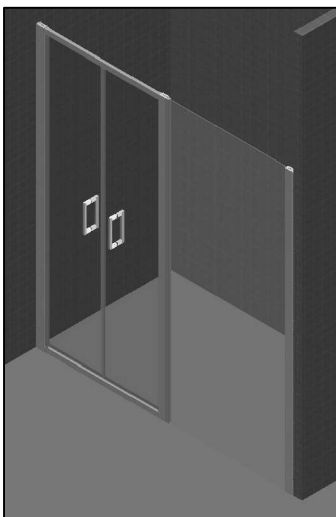

Benötigtes Werkzeug:

Necessary tools:

Outil Nécessaire:

Nářadí potřebné pro montáž:

Potrzebne narzędzia:

Potrebné náradie:

необходимые инструменты:

Herramientas necesarias:



1x

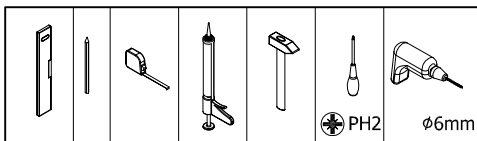

Zubehör:

Equipment:

Accessoires:

Príslušenství:

Dodatki:

Prislušenstvo:

Аксессуары:

Accesorios:



1 x 14196
3,5 x 13mm

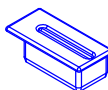

1 x 41330





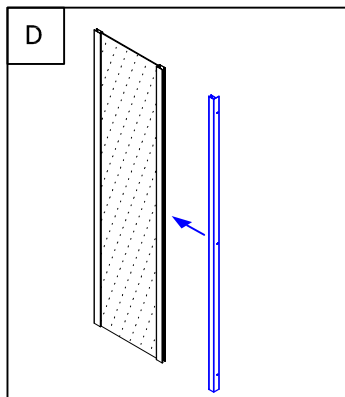
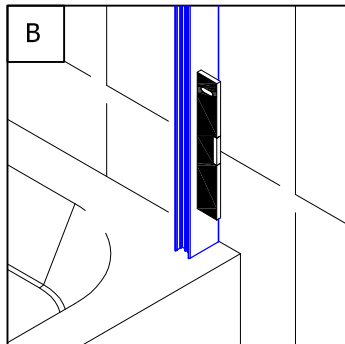
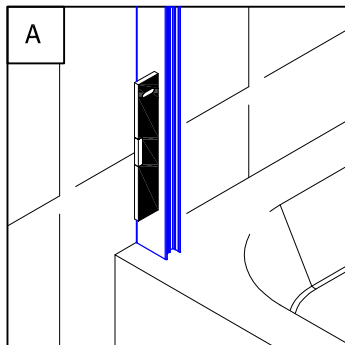
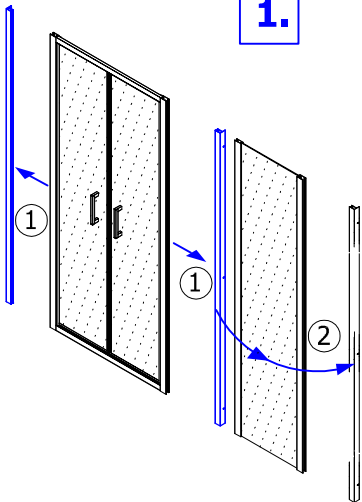

1 x 81237

1.

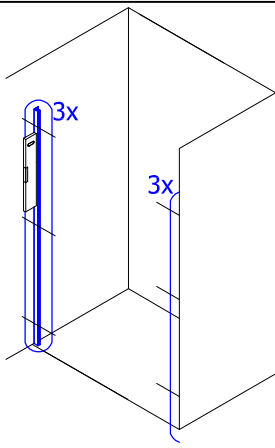

C

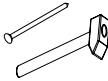

- c1 
- c2 
- c3 
- c4  16000

2.

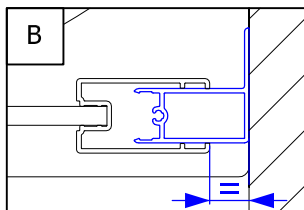
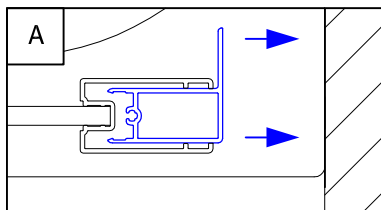
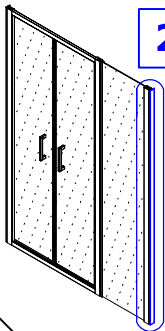

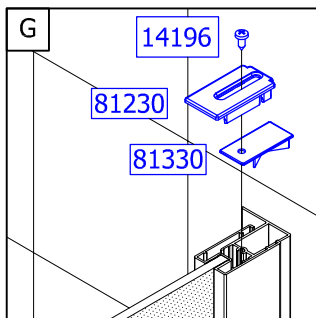
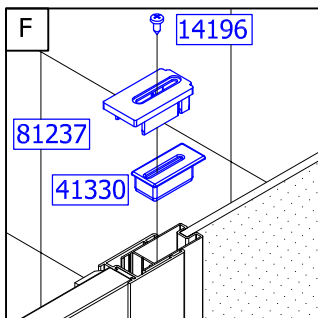
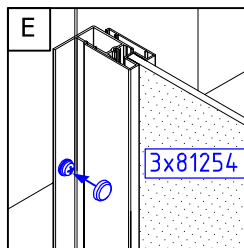
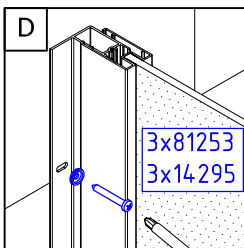
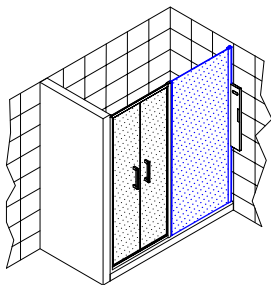

3.

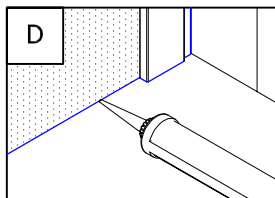
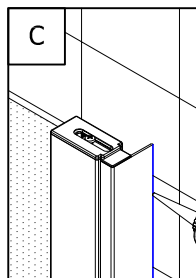
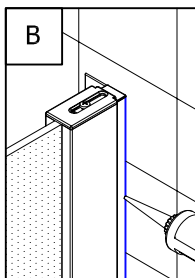
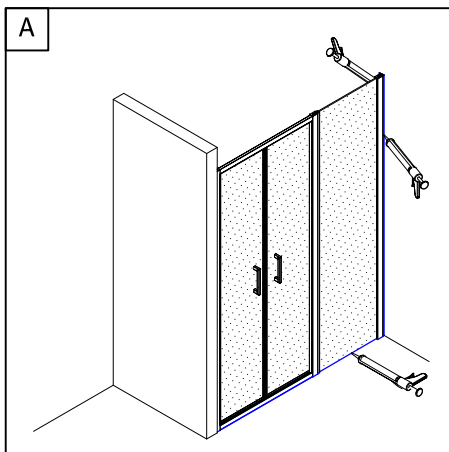

Achtung! Nur Sanitär-Silikon - bakterizid und fungizid eingestellt verwenden.

Caution! Use only bactericidal and fungicide sanitary silicone.

Attention! N'utiliser que du silicone sanitaire bactéricide et fongicide.

Pozor! Používejte pouze baktericidní a fungicidní sanitární silikon.

Uwaga! Stosować tylko silikon sanitarny - bakterio i grzybobójczy.

Pozor! Užívajte pouze baktericidný a fungicidný sanitárny silikón.

Внимание! Применяйте только антибактериальные силиконовые герметики с фунгицидом

Cuidado! Utilizar solamente silicona sanitaria bactericida y fungicida.

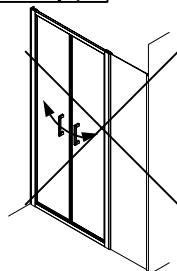
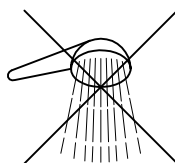

14196
81237
41330

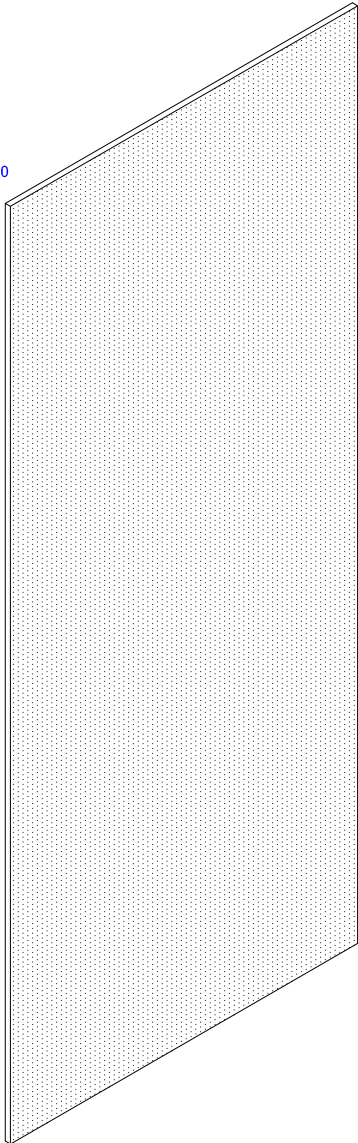
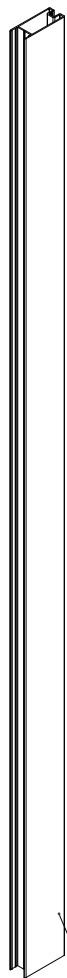

40456

14196
81230
81336

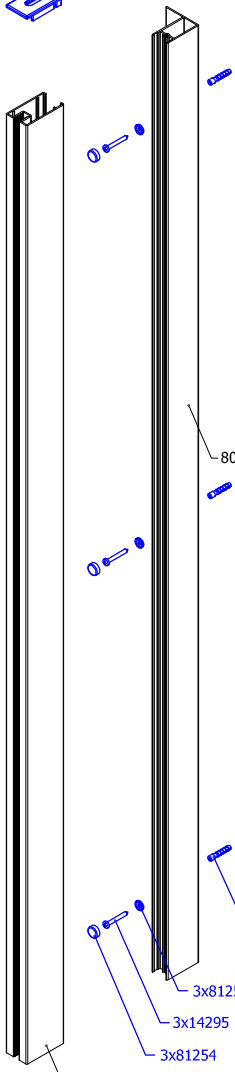

80301

3x16000

3x81253
3x14295
3x81254

80209